

FULLCLEAR[®]

THE CLEANING PROCESS

For further advice please see
www.fullclear.com/start



Disconnect keg couplings and spray each part using the FullClear Connector Spray provided.



Spray around the cleaning sockets removing all visible contaminants using the brush provided and re-spray.

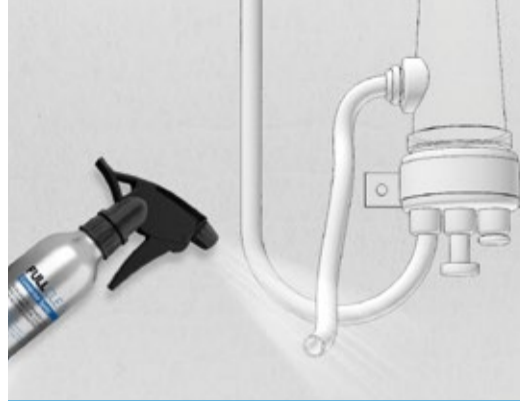

Spray the cellarbuoy bleed line opening.

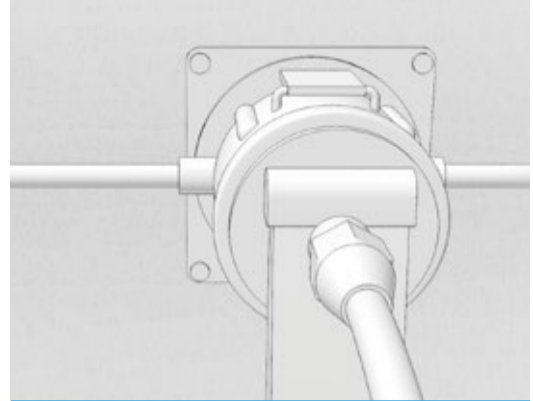

Connect coupling into corresponding cleaning socket.



Remove nozzles / sparklers. Spray and clean threads using the brush provided, then spray again once clear of all contaminants.



Using the brush provided clean away any contaminants under running water.

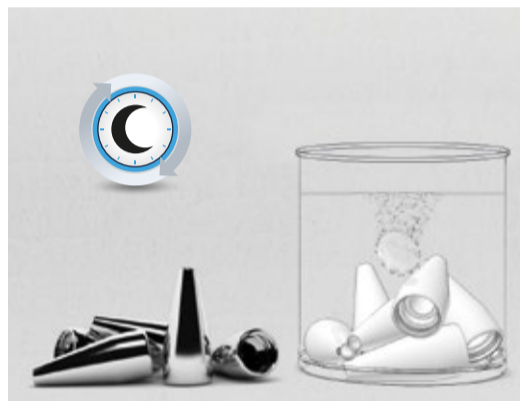

Once clean place nozzles / sparklers in a glass, add 1 Nozzle Cleaning Tablet, fill with clean cold water and leave overnight.



Pour the entire contents of both Activator and Beer Line Cleaner into the cleaning tank FIRST before filling with clean cold water.

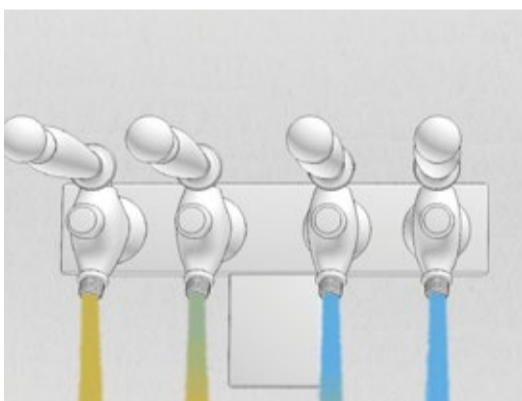

Pull the beer through the lines until you see the FullClear solution then close the taps.

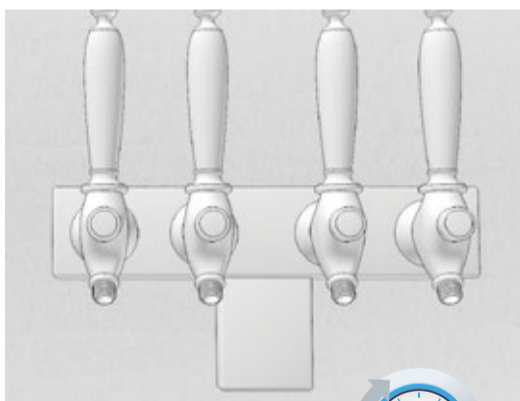

For best results leave FullClear solution in the lines overnight.

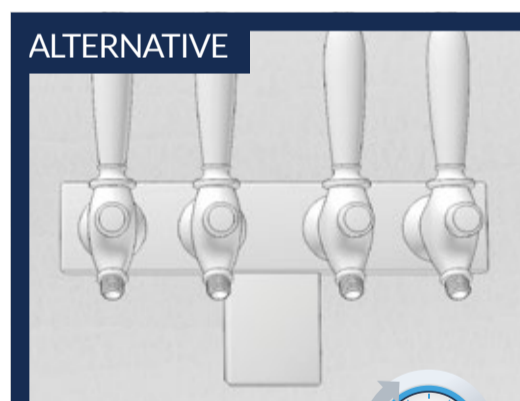

ALTERNATIVE

Alternatively, the solution should be left in the lines for a minimum of 2 hrs.



Every 20 to 30 minutes, open and close the taps to circulate and agitate the lines.



After your cleaning time, fill the tank with clean cold water and pull through the lines.

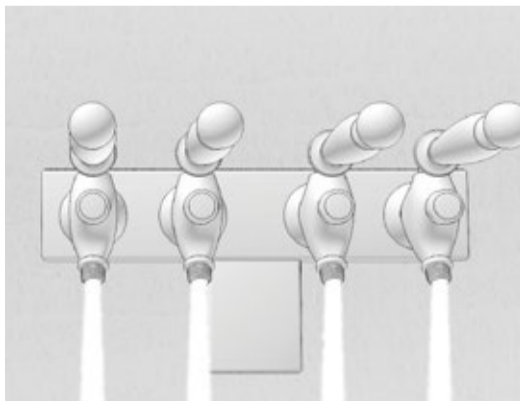

Open and close the taps 3 or 4 times to ensure the lines are thoroughly rinsed.



Reconnect keg couplings.

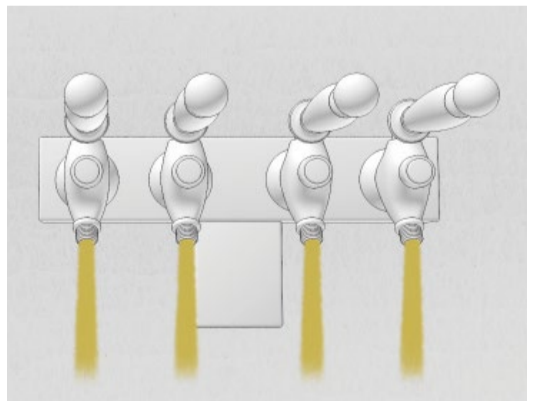

Pull through until beer runs smooth and clear then close the taps. You are now ready to serve the perfect pint.

User protection

When handling chemicals standard Health and Safety guidelines should be followed and gloves are recommended for sensitive skin.

Please consult FullClear MATERIAL SAFETY DATA SHEET

For any queries or technical questions then please call our helpline number on

0845 838 2143